

Apacer

The Most **Reliable**
Storage For Industries

UH110-UFD5



UH110-UFD5

Overview

Apacer UH110-UFD5 is a new generation USB flash drive compatible with the latest USB specification – USB 3.2 Gen1 Super Speed, with a maximum transfer rate of 5.0 Gb/s. The connector is backward compatible with USB 2.0 and USB 1.1 interfaces. With compliance with USB 3.2 specification, this USB drive can deliver up to 275 MB/s outstanding performance and operate at minimal power consumption.

Utilizing 3D NAND for higher capacity up to 64GB and providing more power efficiency than 2D NAND, UH110-UFD5 is designed to replace a conventional IDE hard disk drive. The USB is not only implemented with LDPC (Low Density Parity Check) ECC engine to extend SSD endurance and increase data reliability, but also equipped with Apacer's SLC-liteX technology to perform with higher number of P/E cycles up to 30,000 times. With ESD prevention on mechanism and electronic circuit design, UH110-UFD5 prevents mechanical interference and enhances environment and ESD protection.

In terms of flash management, UH110-UFD5 adopts the latest page mapping file translation layer and comes with various implementations including powerful hardware ECC engine, Wear Leveling, flash block management, S.M.A.R.T., power failure management, Smart Read Refresh™. With its exceptional performance, power efficiency, mechanical protection and increased reliability, UH110-UFD5 is well suited for portable flash storage applications.



Feature

- ESD Prevention: Air discharge $\pm 15\text{KV}$; contact discharge $\pm 8\text{KV}$
- Adopts advanced LDPC ECC engine with 3D NAND flash memory to improve reliability
- Global Wear Leveling
- Flash bad-block management
- 4K Page Mapping
- Power Failure Management
- S.M.A.R.T.
- Smart Read Refresh™

Specifications

Model	UH110-UFD5
Interface	USB 3.2 Gen1
Connector	USB Type A Plug
Form Factor	USB flash drive
NAND Flash Type	3D TLC
Capacity	32GB~64GB
External DRAM	No
Sustained Read Performance (MB/sec)	Up to 275
Sustained Write Performance (MB/sec)	Up to 195
ECC Engine	Low-Density Parity-Check (LDPC) Code
IOPS (4K Random Write)	1500
Standard Operating Temperature (°C)	0 ~ + 70
Extended Operating Temperature (°C)	-40 ~ + 85
Storage Temperature (°C)	-55 ~ + 100
Housing	Yes
H/W Write Protect	No
Shock	Operation: 50G/11ms (compliant with MIL-STD-202G) Non-operation: 1500G/0.5ms (compliant with MIL-STD-883K)
Vibration	Operation: 7.69 Grms, 20~2000 Hz/random (compliant with MIL-STD-810G) Non-operation: 4.02(Grms), 15~2000(Hz)/random (compliant with MIL-STD-810G)
Operating Voltage	5.0 V ± 5%
Power Consumption	Active mode: 200 mA; Idle mode: 80 mA
Dimension (L x W x H)	56.05 x 18.00 x 8.5 (mm)
MTBF (hours)	>3,000,000

Mechanical Specification

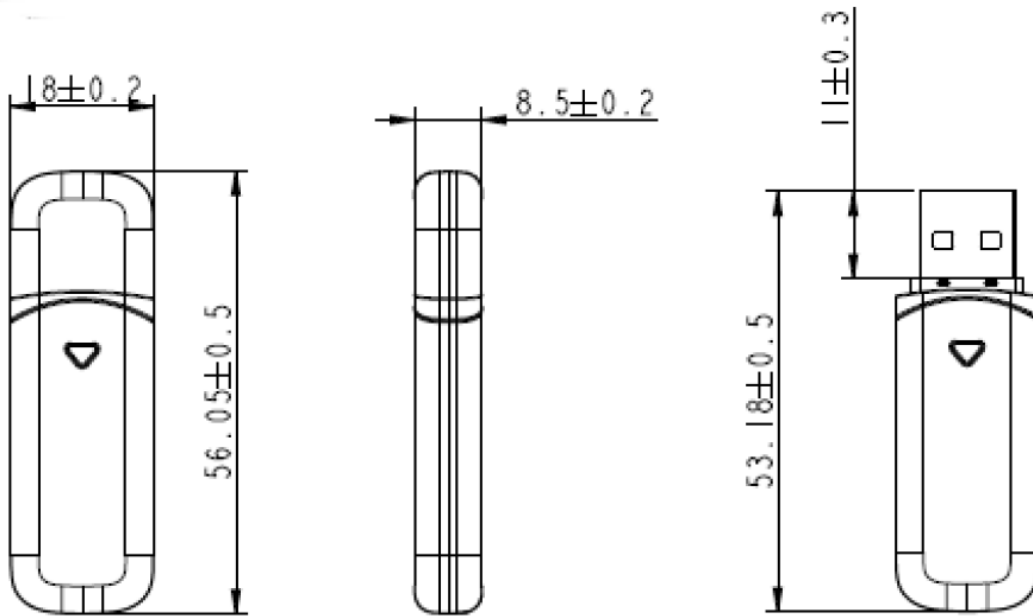

Unit: mm

**For more information,
contact your Apacer representative**

Global Presence

Taiwan (Headquarters)
Apacer Technology Inc.
Tel: +886-2-2267-8000
Fax: +886-2-2267-2261

Europe
Apacer Technology B.V.
Tel: +31-40-267-0000
Fax: +31-40-290-0686

U.S.A.
Apacer Memory America, Inc.
Tel: +1-408-518-8699
Fax: 1-510-249-9551

China
Apacer Electronic(Shanghai)
Co., Ltd.
Tel: +86-21-6228-9939

Japan
Apacer Technology Corp.
Tel: +81-3-5419-2668
Fax: +81-3-5419-0018

India
Apacer Technologies Pvt. Ltd.
Tel: +91-80-41529061~3
Fax: +91-80-41700215